

Relay Module - PLC-RSC- 24DC/21-21



2967060

<https://www.phoenixcontact.com/ae/products/2967060>

Please be informed that the data shown in this PDF document is generated from our Online Catalog. Please find the complete data in the user documentation. Our General Terms of Use for Downloads are valid.



PLC-INTERFACE, consisting of basic terminal block PLC-BSC.../21 with screw connection and plug-in miniature relay with power contact, for assembly on DIN rail NS 35/7,5, 2 changeover contacts, input voltage 24 V DC

Your advantages

- Slim design
- Efficient connection to system cabling using V8 adapter
- RT III sealed relay
- Safe isolation according to DIN EN 50178 between coil and contact
- Functional plug-in bridges
- Integrated input circuit and interference suppression circuit

Commercial Data

| | |
|--------------------------------------|---------------------|
| Item number | 2967060 |
| Packing unit | 10 pc |
| Minimum order quantity | 10 pc |
| Sales Key | CK6 |
| Product Key | CK621C |
| Catalog Page | Page 366 (C-5-2019) |
| GTIN | 4017918156374 |
| Weight per Piece (including packing) | 76.27 g |
| Weight per Piece (excluding packing) | 72.4 g |
| Customs tariff number | 85364190 |
| Country of origin | DE |

Relay Module - PLC-RSC- 24DC/21-21

2967060

<https://www.phoenixcontact.com/ae/products/2967060>

Set consists of

Relay base

Relay base - PLC-BSC- 24DC/21-21 - 2967015

<https://www.phoenixcontact.com/ae/products/2967015>



14 mm PLC basic terminal block with screw connection, without relay or solid-state relay, for mounting on DIN rail NS 35/7,5, 2 changeover contacts, input voltage 24 V DC

Single relay

Single relay - REL-MR- 24DC/21-21 - 2961192

<https://www.phoenixcontact.com/ae/products/2961192>



Plug-in miniature power relay, with power contact, 2 changeover contacts, input voltage 24 V DC

Technical Data

Notes

Utilization restriction

| | |
|----------|---|
| EMC note | EMC: class A product, see manufacturer's declaration in the download area |
|----------|---|

Product properties

| | |
|-------------------------|---------------------------|
| Product type | Relay Module |
| Application | Universal |
| Operating mode | 100% operating factor |
| Mechanical service life | 3x 10 ⁷ cycles |

Insulation characteristics

| | |
|----------------------|---|
| Overvoltage category | III |
| Pollution degree | 3 |
| Insulation | Safe isolation: Control side / contact side |

Electrical properties

| | |
|--|--|
| Maximum power dissipation for nominal condition | 0.43 W |
| Test voltage Winding/contact | 4 kV AC (50 Hz, 1 min., winding/contact) |
| Test voltage Changeover contact/changeover contact | 2.5 kV AC (50 Hz, 1 min., changeover contact/changeover contact) |
| Rated surge voltage | 6 kV |

Input data

Coil side

| | |
|---|--|
| Nominal input voltage U _N | 24 V DC |
| Input voltage range | 20.2 V DC ... 33.6 V DC (20 °C) |
| Typical input current at U _N | 18 mA |
| Typical response time | 8 ms |
| Typical release time | 10 ms |
| Protective circuit | Reverse polarity protection; Polarity protection diode Freewheeling diode; Freewheeling diode |
| Operating voltage display | Yellow LED |

Output data

Switching

| | |
|------------------------|-----------------------|
| Contact type | 2 changeover contacts |
| Type of switch contact | Single contact |
| Drive and function | monostable |
| Drive (polarity) | bipolar |
| Contact material | AgNi |

Relay Module - PLC-RSC- 24DC/21-21



2967060

<https://www.phoenixcontact.com/ae/products/2967060>

| | |
|---------------------------------------|---|
| Maximum switching voltage | 250 V AC/DC (The separating plate PLC-ATP should be installed for voltages larger than 250 V (L1, L2, L3) between identical terminal blocks in adjacent modules. Potential bridging is then carried out with FBST 8-PLC... or ...FBST 500...) |
| Minimum switching voltage | 5 V AC/DC (10 mA) |
| Limiting continuous current | 6 A |
| Maximum inrush current | 15 A (300 ms) |
| Min. switching current | 10 mA (5 V) |
| Interrupting rating (ohmic load) max. | 140 W (at 24 V DC) 85 W (at 48 V DC) 60 W (at 60 V DC) 44 W (at 110 V DC) 60 W (at 220 V DC) 1500 VA (for 250 V AC) |
| Switching capacity | 2 A (at 24 V, DC13) 3 A (at 24 V, AC15) 3 A (at 120 V, AC15) 0.2 A (at 250 V, DC13) 3 A (at 250 V, AC15) |

Connection data

| | |
|----------------------------------|---|
| Connection method | Screw connection |
| Stripping length | 8 mm |
| Screw thread | M3 |
| Conductor cross section solid | 0.14 mm ² ... 2.5 mm ² |
| Conductor cross section flexible | 0.14 mm ² ... 2.5 mm ² 0.2 mm ² ... 2.5 mm ² (Single ferrule) 2x 0.5 mm ² ... 1.5 mm ² (TWIN ferrule) |
| Conductor cross section AWG | 26 ... 14 |
| Tightening torque | 0.6 Nm ... 0.8 Nm |

Dimensions

| | |
|--------|-------|
| Width | 14 mm |
| Height | 80 mm |
| Depth | 94 mm |

Material specifications

| | |
|--|--------------|
| Flammability rating according to UL 94 | V0 (Housing) |
|--|--------------|

Environmental and real-life conditions

Ambient conditions

| | |
|---|-------------------|
| Degree of protection Relay | RT III (Relay) |
| Degree of protection Relay base | IP20 (Relay base) |
| Ambient temperature (operation) | -40 °C ... 60 °C |
| Ambient temperature (storage/transport) | -40 °C ... 85 °C |

Relay Module - PLC-RSC- 24DC/21-21



2967060

<https://www.phoenixcontact.com/ae/products/2967060>

Approval data

Corrosive gas test

| | |
|----------------|----------------------------|
| Identification | ISA-S71.04. G3 Harsh Group |
| | EN 60068-2-60 |

Standards and regulations

| | |
|-----------------------|---------------|
| Standards/regulations | IEC 60947-5-1 |
|-----------------------|---------------|

Mounting

| | |
|-----------------------|---------------------------|
| Mounting type | DIN rail mounting |
| Assembly instructions | in rows with zero spacing |
| Mounting position | any |

Drawings

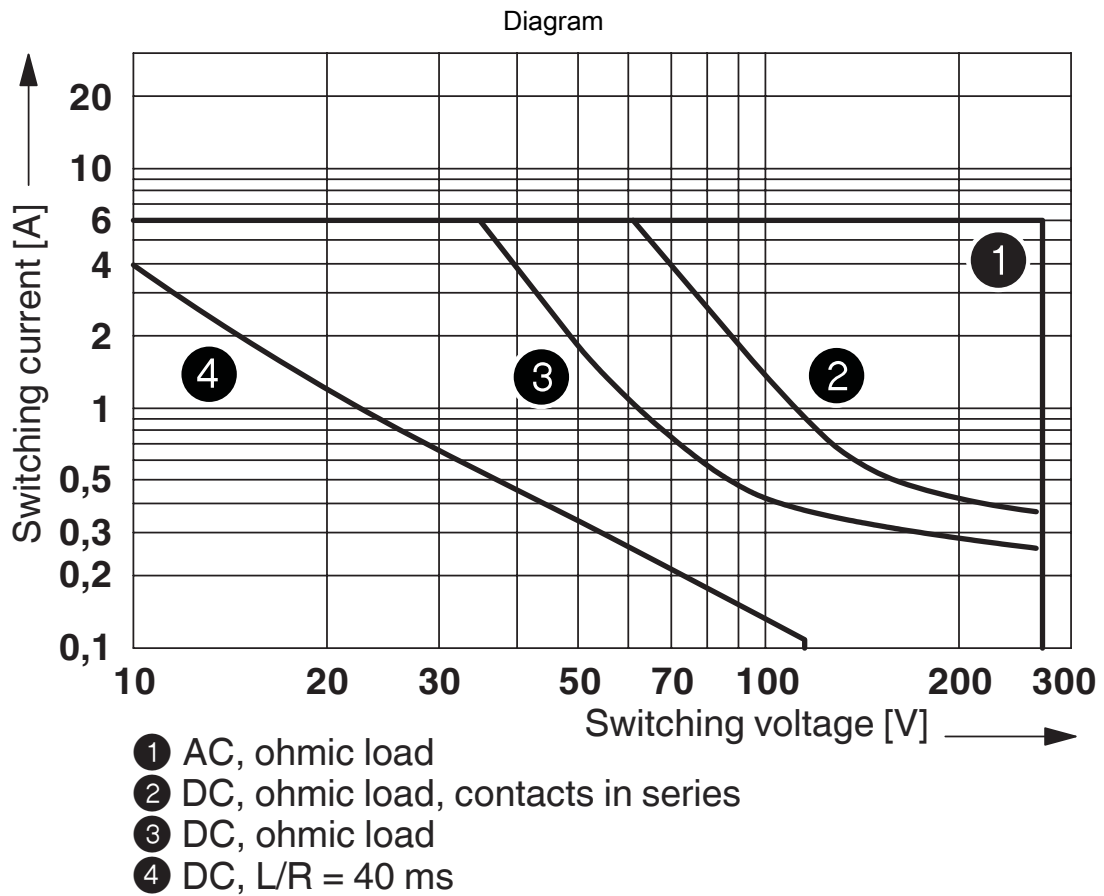

Interrupting rating

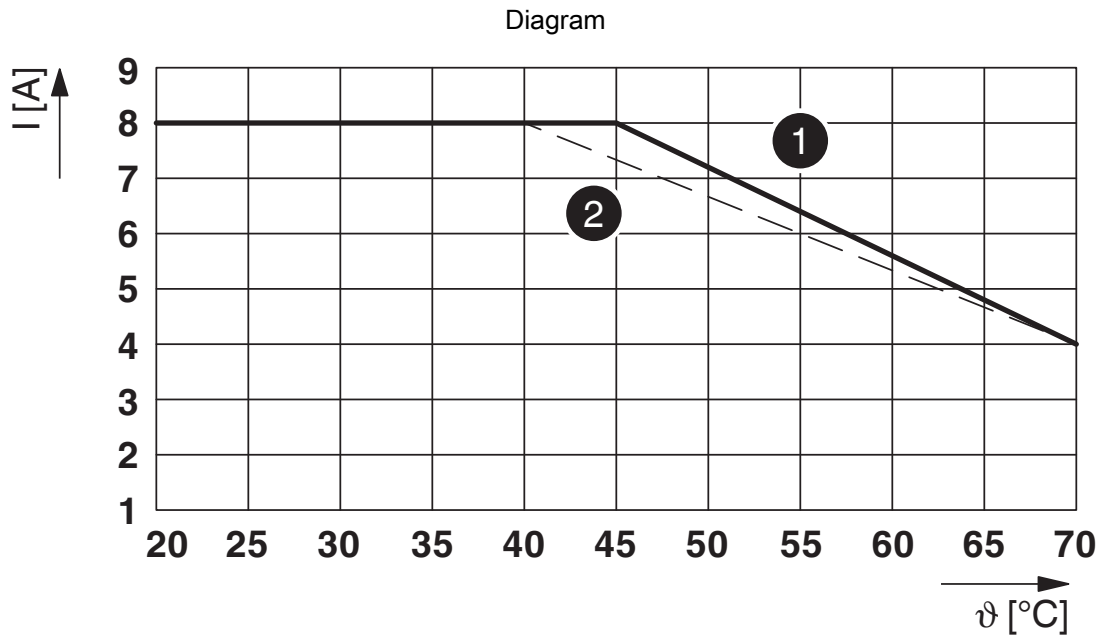

Limiting continuous current per contact for 0.85 ... 1.1 U_N (contact-side)

- (1) Limiting continuous current for horizontal installation position without clearance
- (2) Limiting continuous current for vertical installation position without clearance

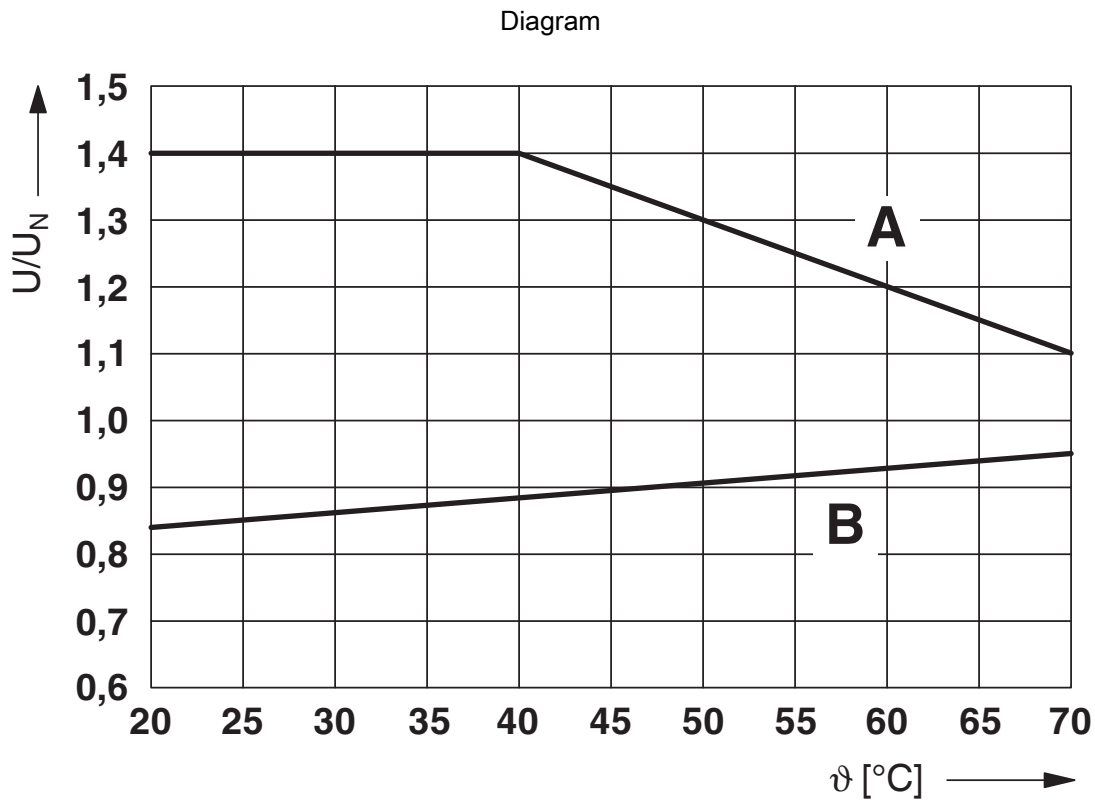

Curve A

Maximum permissible continuous voltage U_{max} with limiting continuous current on the contact side (see relevant technical data)

Curve B

Minimum permissible operate voltage U_{op} after pre-excitation (see relevant technical data)

Relay Module - PLC-RSC- 24DC/21-21



2967060

<https://www.phoenixcontact.com/ae/products/2967060>

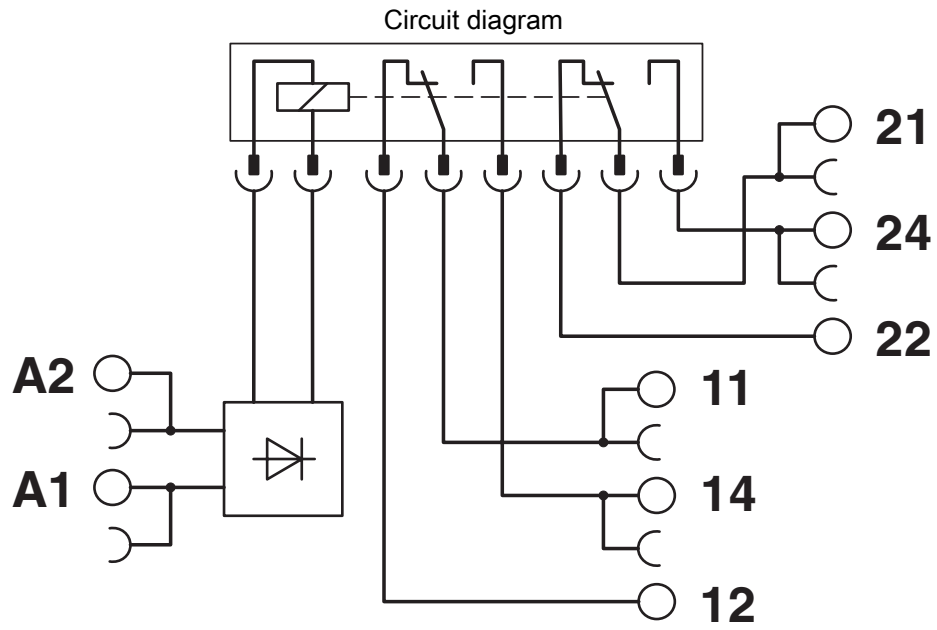

Relay Module - PLC-RSC- 24DC/21-21



2967060

<https://www.phoenixcontact.com/ae/products/2967060>

Approvals



cUL Recognized
Approval ID: FILE E 238705



UL Recognized
Approval ID: FILE E 238705



EAC
Approval ID: TR_TS_D_00573_c



DNV GL
Approval ID: TAE0000196

| Nominal Voltage U_N | Nominal Current I_N | Cross Section AWG | Cross Section mm^2 |
|-----------------------|-----------------------|-------------------|----------------------|
|-----------------------|-----------------------|-------------------|----------------------|

-

-



EAC
Approval ID: RU*C-DE.*08.B.00010



PRS
Approval ID: TE/2109/880590/16



UL Listed
Approval ID: FILE E 172140



cUL Listed
Approval ID: FILE E 172140



RC FRT
Approval ID: B.00094

cULus Recognized

cULus Listed

Relay Module - PLC-RSC- 24DC/21-21



2967060

<https://www.phoenixcontact.com/ae/products/2967060>

Classifications

ECLASS

| | |
|---------------|----------|
| ECLASS-9.0 | 27371601 |
| ECLASS-10.0.1 | 27371601 |
| ECLASS-11.0 | 27371601 |

ETIM

| | |
|----------|----------|
| ETIM 8.0 | EC001437 |
|----------|----------|

UNSPSC

| | |
|-------------|----------|
| UNSPSC 21.0 | 39122300 |
|-------------|----------|

Relay Module - PLC-RSC- 24DC/21-21



2967060

<https://www.phoenixcontact.com/ae/products/2967060>

Environmental Product Compliance

| | |
|------------|--|
| REACH SVHC | Lead 7439-92-1 |
| | Hexahydromethylphthalic anhydride |
| China RoHS | Environmentally Friendly Use Period = 50 years |
| | For information on hazardous substances, refer to the manufacturer's declaration available under "Downloads" |

Relay Module - PLC-RSC- 24DC/21-21

2967060

<https://www.phoenixcontact.com/ae/products/2967060>

Accessories

 Note: Applying some accessories below might limit this product.

Continuous plug-in bridge

Continuous plug-in bridge - FBST 500-PLC RD - 2966786

<https://www.phoenixcontact.com/ae/products/2966786>

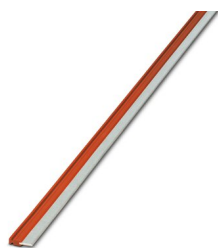

Continuous plug-in bridge, color: red

 Max. current carrying capacity: 32 A

Continuous plug-in bridge

Continuous plug-in bridge - FBST 500-PLC BU - 2966692

<https://www.phoenixcontact.com/ae/products/2966692>

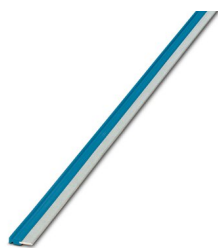

Continuous plug-in bridge, color: blue

 Max. current carrying capacity: 32 A

Relay Module - PLC-RSC- 24DC/21-21

2967060

<https://www.phoenixcontact.com/ae/products/2967060>



Continuous plug-in bridge

Continuous plug-in bridge - FBST 500-PLC GY - 2966838

<https://www.phoenixcontact.com/ae/products/2966838>



Continuous plug-in bridge, color: gray

 Max. current carrying capacity: 32 A

Single plug-in bridge

Single plug-in bridge - FBST 6-PLC RD - 2966236

<https://www.phoenixcontact.com/ae/products/2966236>

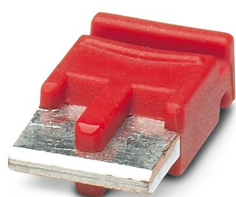

Single plug-in bridge, color: red

 Max. current carrying capacity: 6 A

Relay Module - PLC-RSC- 24DC/21-21

2967060

<https://www.phoenixcontact.com/ae/products/2967060>



Single plug-in bridge

Single plug-in bridge - FBST 6-PLC BU - 2966812

<https://www.phoenixcontact.com/ae/products/2966812>

Single plug-in bridge, color: blue



 Max. current carrying capacity: 6 A

Single plug-in bridge

Single plug-in bridge - FBST 6-PLC GY - 2966825

<https://www.phoenixcontact.com/ae/products/2966825>

Single plug-in bridge, color: gray



 Max. current carrying capacity: 6 A

Relay Module - PLC-RSC- 24DC/21-21

2967060

<https://www.phoenixcontact.com/ae/products/2967060>

Separating plate

Separating plate - PLC-ATP BK - 2966841

<https://www.phoenixcontact.com/ae/products/2966841>



Separating plate, 2 mm thick, required at the start and end of a PLC terminal strip. Furthermore, it is used for: visual separation of groups, safe isolation of different voltages of neighboring PLC relays in acc. with DIN VDE 0106-101, isolation

Power terminal block

Power terminal block - PLC-ESK GY - 2966508

<https://www.phoenixcontact.com/ae/products/2966508>



Power terminal block, for the input of up to four potentials, for mounting on NS 35/7.5

Relay Module - PLC-RSC- 24DC/21-21

2967060

<https://www.phoenixcontact.com/ae/products/2967060>

Screwdriver

Screwdriver - SZF 1-0,6X3,5 - 1204517

<https://www.phoenixcontact.com/ae/products/1204517>



Actuation tool, for ST terminal blocks, also suitable for use as a bladed screwdriver, size: 0.6 x 3.5 x 100 mm, 2-component grip, with non-slip grip

System connection

System connection - PLC-V8L/FLK14/OUT - 2299660

<https://www.phoenixcontact.com/ae/products/2299660>



V8 adapter for 8 x PLC-INTERFACE (14 mm), controller: PLC system cabling of output cards, connection 1: Screw connection 1x, connection 2: IDC/FLK pin strip 1x 14-position, connection 3: Plug-in connection (Can be snapped onto 8x PLC-INTERFACE terminals), number of channels: 8, control logic: plusschaltend

Relay Module - PLC-RSC- 24DC/21-21

2967060

<https://www.phoenixcontact.com/ae/products/2967060>

System connection

System connection - PLC-V8L/FLK14/OUT/M - 2304306

<https://www.phoenixcontact.com/ae/products/2304306>



V8 adapter for 8 x PLC-INTERFACE (14 mm), controller: PLC system cabling of output cards, connection 1: Screw connection 1x, connection 2: IDC/FLK pin strip 1x 14-position, connection 3: Plug-in connection (Can be snapped onto 8x PLC-INTERFACE terminals), number of channels: 8, control logic: minusschaltend

Zack marker strip

Zack marker strip - ZB 10:UNBEDRUCKT - 1053001

<https://www.phoenixcontact.com/ae/products/1053001>



Zack marker strip, Strip, white, unlabeled, can be labeled with: PLOTMARK, CMS-P1-PLOTTER, mounting type: snapped, for terminal block width: 10.2 mm, lettering field size: 10.5 mm x 10.15 mm, Number of individual labels: 10

Relay Module - PLC-RSC- 24DC/21-21

2967060

<https://www.phoenixcontact.com/ae/products/2967060>

Zack marker strip

Zack marker strip - ZB 10 CUS - 0824941

<https://www.phoenixcontact.com/ae/products/0824941>



Zack marker strip, can be ordered: Strip, white, labeled according to customer specifications, mounting type: snap into tall marker groove, for terminal block width: 10.2 mm, lettering field size: 10.15 x 10.5 mm, Number of individual labels: 10

Zack marker strip

Zack marker strip - ZB10,LGS:FORTL.ZAHLEN - 1053014

<https://www.phoenixcontact.com/ae/products/1053014>



Zack marker strip, Strip, white, labeled, can be labeled with: CMS-P1-PLOTTER, printed horizontally: consecutive numbers 1 ... 10, 11 ... 20, etc. up to 91 ... 100, mounting type: snapped, for terminal block width: 10.2 mm, lettering field size: 10.15 x 10.5 mm, Number of individual labels: 10

Relay Module - PLC-RSC- 24DC/21-21

2967060

<https://www.phoenixcontact.com/ae/products/2967060>

Zack marker strip

Zack marker strip - ZB10,QR:FORTL.ZAHLEN - 1053027

<https://www.phoenixcontact.com/ae/products/1053027>



Zack marker strip, Strip, white, labeled, can be labeled with: CMS-P1-PLOTTER, Printed vertically: consecutive numbers 1 ... 10, 11 ... 20, etc. up to 91 ... 100, mounting type: snapped, for terminal block width: 10.2 mm, lettering field size: 10.15 x 10.5 mm, Number of individual labels: 10

Marker for terminal blocks

Marker for terminal blocks - ZB10,LGS:L1-N,PE - 1053412

<https://www.phoenixcontact.com/ae/products/1053412>

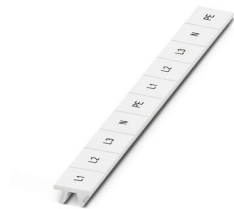

Marker for terminal blocks, Strip, white, labeled, can be labeled with: CMS-P1-PLOTTER, horizontal: L1, L2, L3, N, PE, L1, L2, L3, N, PE, mounting type: snapped, for terminal block width: 10.2 mm, lettering field size: 10.15 x 10.5 mm, Number of individual labels: 10

Relay Module - PLC-RSC- 24DC/21-21



2967060

<https://www.phoenixcontact.com/ae/products/2967060>

Marker for terminal blocks

Marker for terminal blocks - ZB10,LGS:U-N - 1053438

<https://www.phoenixcontact.com/ae/products/1053438>



Marker for terminal blocks, Strip, white, labeled, can be labeled with: CMS-P1-PLOTTER, horizontal: U, V, W, N, GND, U, V, W, N, GND, mounting type: snapped, for terminal block width: 10.2 mm, lettering field size: 10.15 x 10.5 mm, Number of individual labels: 10

Marker for terminal blocks

Marker for terminal blocks - UC-TM 10 - 0818069

<https://www.phoenixcontact.com/ae/products/0818069>



Marker for terminal blocks, Sheet, white, unlabeled, can be labeled with: BLUEMARK ID COLOR, BLUEMARK ID, BLUEMARK CLED, PLOTMARK, CMS-P1-PLOTTER, mounting type: snapped, for terminal block width: 10.2 mm, lettering field size: 9.6 x 10.5 mm, Number of individual labels: 48

Relay Module - PLC-RSC- 24DC/21-21



2967060

<https://www.phoenixcontact.com/ae/products/2967060>

Marker for terminal blocks

Marker for terminal blocks - UC-TM 10 CUS - 0824605

<https://www.phoenixcontact.com/ae/products/0824605>



Marker for terminal blocks, can be ordered: by sheet, white, labeled according to customer specifications, mounting type: snap into tall marker groove, for terminal block width: 10.2 mm, lettering field size: 9.6 x 10.5 mm, Number of individual labels: 48

Marker for terminal blocks

Marker for terminal blocks - UCT-TM 10 - 0829142

<https://www.phoenixcontact.com/ae/products/0829142>



Marker for terminal blocks, Sheet, white, unlabeled, can be labeled with: TOPMARK NEO, TOPMARK LASER, BLUEMARK ID COLOR, BLUEMARK ID, BLUEMARK CLED, THERMOMARK PRIME, THERMOMARK CARD 2.0, THERMOMARK CARD, mounting type: snapped, for terminal block width: 10.2 mm, lettering field size: 8.9 x 9.6 mm, Number of individual labels: 36

Relay Module - PLC-RSC- 24DC/21-21



2967060

<https://www.phoenixcontact.com/ae/products/2967060>

Marker for terminal blocks

Marker for terminal blocks - UCT-TM 10 CUS - 0829623

<https://www.phoenixcontact.com/ae/products/0829623>



Marker for terminal blocks, can be ordered: by sheet, white, labeled according to customer specifications, mounting type: snap into tall marker groove, for terminal block width: 10.2 mm, lettering field size: 8.9 x 9.6 mm, Number of individual labels: 36

Zack marker strip

Zack marker strip - ZB 12:UNPRINTED - 0812120

<https://www.phoenixcontact.com/ae/products/0812120>



Zack marker strip, Strip, white, unlabeled, can be labeled with: PLOTMARK, CMS-P1-PLOTTER, mounting type: snapped, for terminal block width: 12.2 mm, lettering field size: 12 x 10.5 mm, Number of individual labels: 5

Relay Module - PLC-RSC- 24DC/21-21

2967060

<https://www.phoenixcontact.com/ae/products/2967060>

Zack marker strip

Zack marker strip - ZB 12 CUS - 0824942

<https://www.phoenixcontact.com/ae/products/0824942>

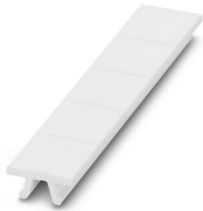

Zack marker strip, can be ordered: Strip, white, labeled according to customer specifications, mounting type: snap into tall marker groove, for terminal block width: 12.2 mm, lettering field size: 10.5 x 12.15 mm, Number of individual labels: 5

Zack marker strip

Zack marker strip - ZB 12,LGS:L1-N,PE - 0812146

<https://www.phoenixcontact.com/ae/products/0812146>



Zack marker strip, Strip, white, labeled, printed horizontally: L1, L2, L3, N, PE, mounting type: snapped, for terminal block width: 12.2 mm, lettering field size: 10.5 x 12.15 mm, Number of individual labels: 5

Relay Module - PLC-RSC- 24DC/21-21

2967060

<https://www.phoenixcontact.com/ae/products/2967060>

Marker for terminal blocks

Marker for terminal blocks - UC-TM 12 - 0819194

<https://www.phoenixcontact.com/ae/products/0819194>



Marker for terminal blocks, Sheet, white, unlabeled, can be labeled with: BLUEMARK ID COLOR, BLUEMARK ID, BLUEMARK CLED, PLOTMARK, CMS-P1-PLOTTER, mounting type: snapped, for terminal block width: 12 mm, lettering field size: 11.45 x 10.5 mm, Number of individual labels: 40

Marker for terminal blocks

Marker for terminal blocks - UC-TM 12 CUS - 0824613

<https://www.phoenixcontact.com/ae/products/0824613>



Marker for terminal blocks, can be ordered: by sheet, white, labeled according to customer specifications, mounting type: snap into tall marker groove, for terminal block width: 12 mm, lettering field size: 11.45 x 10.5 mm, Number of individual labels: 40

Relay Module - PLC-RSC- 24DC/21-21

2967060

<https://www.phoenixcontact.com/ae/products/2967060>

Marker for terminal blocks

Marker for terminal blocks - UCT-TM 12 - 0829144

<https://www.phoenixcontact.com/ae/products/0829144>



Marker for terminal blocks, Sheet, white, unlabeled, can be labeled with: TOPMARK NEO, TOPMARK LASER, BLUEMARK ID COLOR, BLUEMARK ID, BLUEMARK CLED, THERMOMARK PRIME, THERMOMARK CARD 2.0, THERMOMARK CARD, mounting type: snapped, for terminal block width: 12 mm, lettering field size: 10.8 x 9.6 mm, Number of individual labels: 30

Marker for terminal blocks

Marker for terminal blocks - UCT-TM 12 CUS - 0829630

<https://www.phoenixcontact.com/ae/products/0829630>



Marker for terminal blocks, can be ordered: by sheet, white, labeled according to customer specifications, mounting type: snap into tall marker groove, for terminal block width: 12 mm, lettering field size: 10.8 x 9.6 mm, Number of individual labels: 30

Relay Module - PLC-RSC- 24DC/21-21

2967060

<https://www.phoenixcontact.com/ae/products/2967060>

DIN rail perforated

DIN rail perforated - NS 35/ 7,5 PERF 2000MM - 0801733

<https://www.phoenixcontact.com/ae/products/0801733>



DIN rail perforated, acc. to EN 60715, material: Steel, galvanized, passivated with a thick layer, Standard profile, color: silver, Pack of 25 (50 m)

DIN rail, unperforated

DIN rail, unperforated - NS 35/ 7,5 UNPERF 2000MM - 0801681

<https://www.phoenixcontact.com/ae/products/0801681>



DIN rail, unperforated, acc. to EN 60715, material: Steel, galvanized, passivated with a thick layer, Standard profile, color: silver, Pack of 25 (50 m)

Relay Module - PLC-RSC- 24DC/21-21

2967060

<https://www.phoenixcontact.com/ae/products/2967060>

DIN rail perforated

DIN rail perforated - NS 35/ 7,5 WH PERF 2000MM - 1204119

<https://www.phoenixcontact.com/ae/products/1204119>



DIN rail perforated, acc. to EN 60715, material: Steel, Galvanized, white passivated, Standard profile, color: silver, Pack of 25 (50 m)

DIN rail, unperforated

DIN rail, unperforated - NS 35/ 7,5 WH UNPERF 2000MM-VPE 10 - 1204122

<https://www.phoenixcontact.com/ae/products/1204122>



DIN rail, unperforated, acc. to EN 60715, material: Steel, Galvanized, white passivated, Standard profile, color: silver, Pack of 10 (20 m)

Relay Module - PLC-RSC- 24DC/21-21

2967060

<https://www.phoenixcontact.com/ae/products/2967060>

DIN rail, unperforated

DIN rail, unperforated - NS 35/ 7,5 AL UNPERF 2000MM - 0801704

<https://www.phoenixcontact.com/ae/products/0801704>



DIN rail, unperforated, acc. to EN 60715, material: Aluminum, uncoated, Standard profile, color: silver, Pack of 25 (50 m)

DIN rail perforated

DIN rail perforated - NS 35/ 7,5 ZN PERF 2000MM - 1206421

<https://www.phoenixcontact.com/ae/products/1206421>



DIN rail perforated, acc. to EN 60715, material: Steel, galvanized, Standard profile, color: silver, Pack of 25 (50 m)

Relay Module - PLC-RSC- 24DC/21-21

2967060

<https://www.phoenixcontact.com/ae/products/2967060>

DIN rail, unperforated

DIN rail, unperforated - NS 35/ 7,5 ZN UNPERF 2000MM - 1206434

<https://www.phoenixcontact.com/ae/products/1206434>



DIN rail, unperforated, acc. to EN 60715, material: Steel, galvanized, Standard profile, color: silver, Pack of 25 (50 m)

DIN rail, unperforated

DIN rail, unperforated - NS 35/ 7,5 CU UNPERF 2000MM-VPE 10 - 0801762

<https://www.phoenixcontact.com/ae/products/0801762>



DIN rail, unperforated, acc. to EN 60715, material: Copper, uncoated, Standard profile, color: copper-colored, Pack of 10 (20 m)

Relay Module - PLC-RSC- 24DC/21-21

2967060

<https://www.phoenixcontact.com/ae/products/2967060>

End cap

End cap - NS 35/ 7,5 CAP - 1206560

<https://www.phoenixcontact.com/ae/products/1206560>

DIN rail end piece, for DIN rail NS 35/7.5



DIN rail perforated

DIN rail perforated - NS 35/15 PERF 2000MM - 1201730

<https://www.phoenixcontact.com/ae/products/1201730>



DIN rail perforated, similar to EN 60715, material: Steel, galvanized, passivated with a thick layer, Standard profile, color: silver, Pack of 25 (50 m)

Relay Module - PLC-RSC- 24DC/21-21

2967060

<https://www.phoenixcontact.com/ae/products/2967060>

DIN rail, unperforated

DIN rail, unperforated - NS 35/15 UNPERF 2000MM - 1201714

<https://www.phoenixcontact.com/ae/products/1201714>



DIN rail, unperforated, similar to EN 60715, material: Steel, galvanized, passivated with a thick layer, Standard profile, color: silver, Pack of 25 (50 m)

DIN rail perforated

DIN rail perforated - NS 35/15 WH PERF 2000MM - 0806602

<https://www.phoenixcontact.com/ae/products/0806602>



DIN rail perforated, similar to EN 60715, material: Steel, Galvanized, white passivated, Standard profile, color: white, Pack of 25 (50 m)

Relay Module - PLC-RSC- 24DC/21-21

2967060

<https://www.phoenixcontact.com/ae/products/2967060>

DIN rail, unperforated

DIN rail, unperforated - NS 35/15 WH UNPERF 2000MM-VPE 10 - 1204135

<https://www.phoenixcontact.com/ae/products/1204135>



DIN rail, unperforated, similar to EN 60715, material: Steel, Galvanized, white passivated, Standard profile, color: silver, Pack of 10 (20 m)

DIN rail, unperforated

DIN rail, unperforated - NS 35/15 AL UNPERF 2000MM - 1201756

<https://www.phoenixcontact.com/ae/products/1201756>



DIN rail, unperforated, similar to EN 60715, material: Aluminum, uncoated, Standard profile, color: silver

Relay Module - PLC-RSC- 24DC/21-21

2967060

<https://www.phoenixcontact.com/ae/products/2967060>

DIN rail perforated

DIN rail perforated - NS 35/15 ZN PERF 2000MM - 1206599

<https://www.phoenixcontact.com/ae/products/1206599>



DIN rail perforated, similar to EN 60715, material: Steel, galvanized, Standard profile, color: silver, Pack of 25 (50 m)

DIN rail, unperforated

DIN rail, unperforated - NS 35/15 ZN UNPERF 2000MM - 1206586

<https://www.phoenixcontact.com/ae/products/1206586>



DIN rail, unperforated, similar to EN 60715, material: Steel, galvanized, Standard profile, color: silver, Pack of 25 (50 m)

Relay Module - PLC-RSC- 24DC/21-21

2967060

<https://www.phoenixcontact.com/ae/products/2967060>

DIN rail, unperforated

DIN rail, unperforated - NS 35/15 CU UNPERF 2000MM-VPE 10 - 1201895

<https://www.phoenixcontact.com/ae/products/1201895>



DIN rail, unperforated, similar to EN 60715, material: Copper, uncoated, Standard profile, color: copper-colored, Pack of 10 (20 m)

End cap

End cap - NS 35/15 CAP - 1206573

<https://www.phoenixcontact.com/ae/products/1206573>

DIN rail end piece, for DIN rail NS 35/15



Relay Module - PLC-RSC- 24DC/21-21

2967060

<https://www.phoenixcontact.com/ae/products/2967060>

DIN rail, unperforated

DIN rail, unperforated - NS 35/15-2,3 UNPERF 2000MM-VPE 10 - 1201798

<https://www.phoenixcontact.com/ae/products/1201798>



DIN rail, unperforated, acc. to EN 60715, material: Steel, galvanized, passivated with a thick layer, Standard profile 2.3 mm, color: silver, Pack of 10 (20 m)

Relay base

Relay base - PLC-BSC- 24DC/21-21 - 2967015

<https://www.phoenixcontact.com/ae/products/2967015>



14 mm PLC basic terminal block with screw connection, without relay or solid-state relay, for mounting on DIN rail NS 35/7,5, 2 changeover contacts, input voltage 24 V DC

Relay Module - PLC-RSC- 24DC/21-21



2967060

<https://www.phoenixcontact.com/ae/products/2967060>

Single relay

Single relay - REL-MR- 24DC/21-21 - 2961192

<https://www.phoenixcontact.com/ae/products/2961192>

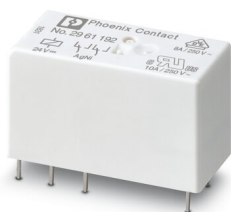

Plug-in miniature power relay, with power contact, 2 changeover contacts, input voltage 24 V DC

Phoenix Contact 2022 © - all rights reserved

<https://www.phoenixcontact.com>

PHOENIX CONTACT Middle East FZ LLC
1201N-1206N, Dubai Science Park Towers – North
P.O. Box 345002, Dubai, United Arab Emirates
(+971) 4 437-0324
info-me@phoenixcontact.com