

## DRM270110LT

**Weidmüller Interface GmbH & Co. KG**  
 Klingenbergstraße 26  
 D-32758 Detmold  
 Germany

www.weidmueller.com

### Product image



Similar to illustration

Individual relays within the D-SERIES DRM

- 2 CO contacts
- AC coils
- With integrated status LED and test button

### General ordering data

Version	D-SERIES DRM, Relay, Number of contacts: 2, CO contact, AgNi flash gold-plated, Rated control voltage: 110 V DC, Continuous current: 10 A, Plug-in connection
Order No.	<a href="#">7760056071</a>
Type	DRM270110LT
GTIN (EAN)	4032248855841
Qty.	20 pc(s).

Creation date April 26, 2022 4:30:11 AM CEST

Catalogue status 08.04.2022 / We reserve the right to make technical changes.

**DRM270110LT****Weidmüller Interface GmbH & Co. KG**

Klingenbergstraße 26

D-32758 Detmold

Germany

www.weidmueller.com

**Technical data****Dimensions and weights**

Depth	35.7 mm	Depth (inches)	1.406 inch
Height	27.4 mm	Height (inches)	1.079 inch
Width	21 mm	Width (inches)	0.827 inch
Net weight	34.15 g		

**Temperatures**

Storage temperature	-40 °C...70 °C	Operating temperature	-40 °C...60 °C
Humidity	35...85 % rel. humidity, no condensation		

**Environmental Product Compliance**

REACH SVHC	Lead 7439-92-1
------------	----------------

**Rated data UL**

Certificate No. (cURus)	E312083
-------------------------	---------

**Control side**

Rated control voltage	110 V DC	Rated current DC	10 mA
Power rating	1.2 W	Pull-in/drop-out voltage, typ.	82.5 V / 11 V DC
Coil resistance	11000 Ω ± 10 %	Coil tolerance	10 %
Status indicator	Green LED		

**Load side**

Rated switching voltage	250 V AC	Continuous current	10 A
Max. switching frequency at rated load	0.1 Hz	Min. switching power	10 mA @ 12 V, 100 mA @ 5 V
Inrush current	20 A / 50 ms	AC switching capacity (resistive), max.	2500 VA
DC switching capacity (resistive), max.	240 W @ 24 V	Switch-on delay	< 20 ms
Switch-off delay	< 20 ms	Contact type	2 CO contact (AgNi flash gold-plated)
Mechanical service life	20 x 10 <sup>6</sup> switching cycles		

**General data**

Test button available	Yes		
Version of test button	lockable		
Mechanical switch position indicator	Yes		
Colour	Transparent		
UL94 flammability rating component	Component	Relay cover	
	UL94 flammability rating	V-2	
	Component	Relay baseplate	
	UL94 flammability rating	V-0	
	Component	Relay status indicator	
	UL94 flammability rating	HB	
	Component	Relay test button	
	UL94 flammability rating	HB	

## DRM270110LT

Weidmüller Interface GmbH &amp; Co. KG

Klingenbergstraße 26

D-32758 Detmold

Germany

www.weidmueller.com

## Technical data

## Insulation coordination

Rated voltage	250 V	Pollution severity	2
Surge voltage category	III	Clearance and creepage distances for control side - load side	≥ 5.5 mm
Dielectric strength for control side - load side	1.8 kV <sub>eff</sub> / 1 min.	Dielectric strength of neighbouring contacts	1 kV <sub>eff</sub> / 1 min
Dielectric strength of open contact	1 kV <sub>eff</sub> / 1 min	Impulse withstand voltage	6 kV (1.2/50 μs)
Protection degree	IP20		

## Further details of approvals / standards

Standards	IEC 61810-1, EN 60664-1:2007, EN 61000-6-2:2005, EN 61000-6-4:2007 + A1:2011, UL 508	Certificate No. (cURus)	E312083
-----------	--	-------------------------	---------

## Connection data

Wire connection method	Plug-in connection
------------------------	--------------------

## Classifications

ETIM 6.0	EC001437	ETIM 7.0	EC001437
ETIM 8.0	EC001437	ECLASS 9.0	27-37-16-01
ECLASS 9.1	27-37-16-01	ECLASS 10.0	27-37-16-01
ECLASS 11.0	27-37-16-01		

## Approvals

Approvals



ROHS	Conform
UL File Number Search	E312083

## Downloads

Approval/Certificate/Document of Conformity	<a href="#">EU Konformitätserklärung / EU Declaration of Conformity</a>
Engineering Data	<a href="#">CAD data – STEP</a>
Engineering Data	<a href="#">EPLAN, WSCAD</a>
Catalogues	<a href="#">Catalogues in PDF-format</a>
Brochures	

**DRM270110LT**

**Weidmüller Interface GmbH & Co. KG**  
 Klingenbergstraße 26  
 D-32758 Detmold  
 Germany

www.weidmueller.com

**Drawings**

**Wiring diagram**

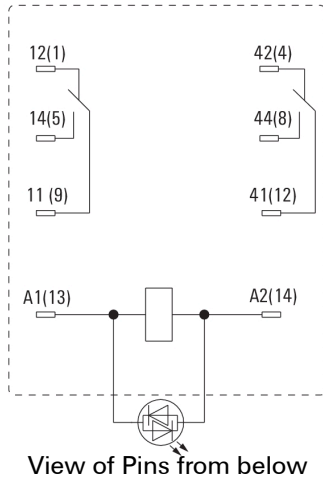

**Graph**

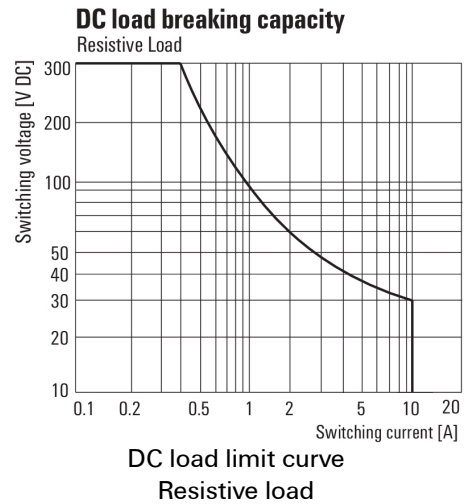

**Graph**

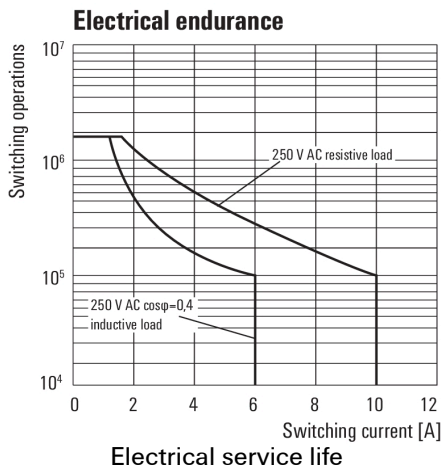

**Graph**

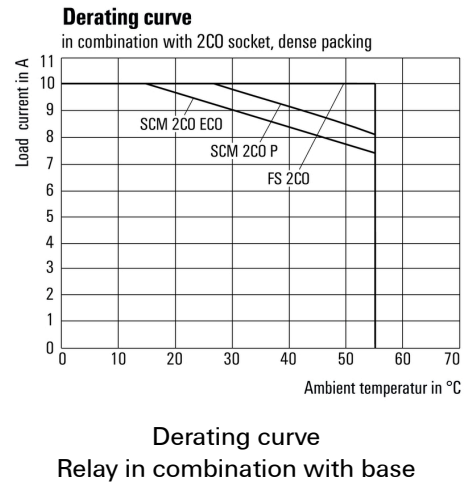

**Graph**

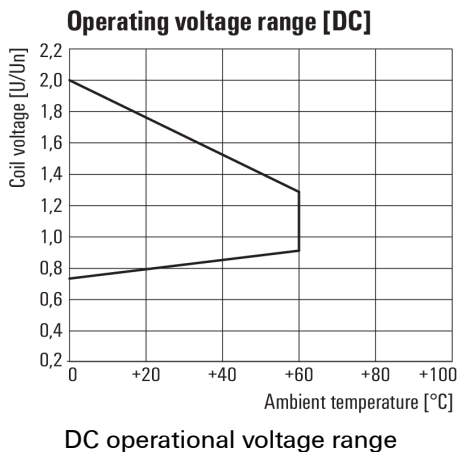

**Dimensional drawing**

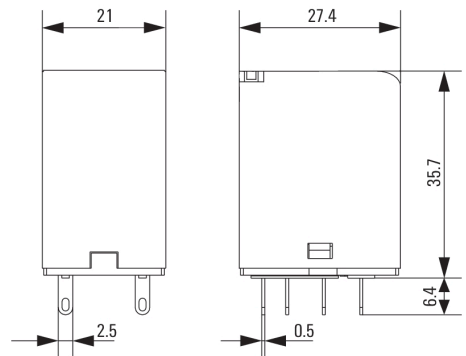

## DRM270110LT

**Weidmüller Interface GmbH & Co. KG**

Klingenbergstraße 26

D-32758 Detmold

Germany

www.weidmueller.com

## Mating connector (fully pluggable)

### Sockets



Relay sockets for the D-SERIES DRM relays

- 2 and 4 CO contacts
- Screw and PUSH IN connection
- Standard and low heights

### General ordering data

Type	SCM 2CO P	Version
Order No.	<a href="#">7760056362</a>	D-SERIES DRM, Relay socket, Number of contacts: 2, CO contact,
GTIN (EAN)	6944169772269	Continuous current: 12 A, PUSH IN
Qty.	10 pc(s).	
Type	SCM 4CO P	Version
Order No.	<a href="#">7760056363</a>	D-SERIES DRM, Relay socket, Number of contacts: 4, CO contact,
GTIN (EAN)	6944169772276	Continuous current: 6 A, PUSH IN
Qty.	10 pc(s).	
Type	FS 4CO	Version
Order No.	<a href="#">7760056107</a>	D-SERIES DRM, Relay socket, Number of contacts: 4, CO contact,
GTIN (EAN)	4032248855575	Continuous current: 10 A, Screw connection
Qty.	10 pc(s).	
Type	SCM 4CO ECO	Version
Order No.	<a href="#">7760056264</a>	D-SERIES DRM, Relay socket, Number of contacts: 4, CO contact,
GTIN (EAN)	6944169662973	Continuous current: 6 A, Screw connection
Qty.	10 pc(s).	
Type	SCM 2CO ECO	Version
Order No.	<a href="#">7760056263</a>	D-SERIES DRM, Relay socket, Number of contacts: 2, CO contact,
GTIN (EAN)	6944169662966	Continuous current: 12 A, Screw connection
Qty.	10 pc(s).	
Type	FS 2CO	Version
Order No.	<a href="#">7760056106</a>	D-SERIES DRM, Relay socket, Number of contacts: 2, CO contact,
GTIN (EAN)	4032248855582	Continuous current: 12 A, Screw connection
Qty.	10 pc(s).	

**DRM270110LT**

**Weidmüller Interface GmbH & Co. KG**  
 Klingenbergstraße 26  
 D-32758 Detmold  
 Germany

www.weidmueller.com

**Accessories**

**ESG 6/17**



**Guaranteed long service life: ESG**

The multi-colour and multi-format labels have a strong adhesive layer to ensure the best possible adhesion to the underlying surface. Double laminated polyester makes the basic material very thin and yet extremely tear-resistant.

**Your benefits with MultiMark**

- “Different materials for various requirements”
- Can be used with equipment from many manufacturers
- Device markers with a familiar design

**General ordering data**

Type	ESG 6/17 MM WS	Version
Order No.	<a href="#">2005100000</a>	ESG, Device markers, 6 x 17 mm, white
GTIN (EAN)	4050118390728	
Qty.	3,000 pc(s).	

**Blank**



ESG is the tried-and-tested marker in MultiCard format for use on many well-known electrical devices. The result is high-quality device marking with a high-contrast appearance.

Various types are available for devices from manufacturers like Siemens, ABB, Beckhoff etc.

Advantages at a glance:

- Tags for universal usage, self-adhesive or clip-on tags, depending on type
- For aligned equipment, e.g. circuit breakers, we supply ESG markers for clipping onto tag rails
- Individual laser-quality printing according to specifications

**For custom printing:** Please send us a file of our labeling software M-Print PRO or M-Print PRO Online (without installation) for your labeling specifications.

**General ordering data**

Type	ESG 6/15 K MC NE GE	Version
Order No.	<a href="#">1880130000</a>	ESG, Device markers x 15 mm, PA 66, Colour: yellow, Self-adhesive
GTIN (EAN)	4032248478910	
Qty.	200 pc(s).	

Type	ESG 6/15 K MC NE WS	Version
Order No.	<a href="#">1880100000</a>	ESG, Device markers x 15 mm, PA 66, Colour: white, Self-adhesive
GTIN (EAN)	4032248478781	
Qty.	200 pc(s).	

## DRM270110LT

**Weidmüller Interface GmbH & Co. KG**  
 Klingenbergstraße 26  
 D-32758 Detmold  
 Germany

www.weidmueller.com

## Accessories

## Custom printing



ESG is the tried-and-tested marker in MultiCard format for use on many well-known electrical devices. The result is high-quality device marking with a high-contrast appearance.

Various types are available for devices from manufacturers like Siemens, ABB, Beckhoff etc. Advantages at a glance:

- Tags for universal usage, self-adhesive or clip-on tags, depending on type
- For aligned equipment, e.g. circuit breakers, we supply ESG markers for clipping onto tag rails
- Individual laser-quality printing according to specifications

**For custom printing:** Please send us a file of our labeling software M-Print PRO or M-Print PRO Online (without installation) for your labeling specifications.

## General ordering data

Type	ESG 9/26 SCM ECO MC SDR	Version
Order No.	<a href="#">1525800000</a>	ESG, Device markers x 26 mm, PA 66, Colour: To customer
GTIN (EAN)	4050118331875	specification
Qty.	80 pc(s).	

## Protection modules



Pluggable protective modules for the D-SERIES relay sockets, with optional protective functions.

- With free-wheeling diode or RC filter

## General ordering data

Type	RIM 1 6/230VDC	Version
Order No.	<a href="#">7760056169</a>	D-SERIES, Free-wheeling diode, Rated control voltage: 6...230 V, Plug-
GTIN (EAN)	4032248967728	in connection
Qty.	10 pc(s).	

## DRM270110LT

**Weidmüller Interface GmbH & Co. KG**  
 Klingenbergstraße 26  
 D-32758 Detmold  
 Germany

www.weidmueller.com

# Accessories

## Blank



ESG is the tried-and-tested marker in MultiCard format for use on many well-known electrical devices. The result is high-quality device marking with a high-contrast appearance.

Various types are available for devices from manufacturers like Siemens, ABB, Beckhoff etc. Advantages at a glance:

- Tags for universal usage, self-adhesive or clip-on tags, depending on type
- For aligned equipment, e.g. circuit breakers, we supply ESG markers for clipping onto tag rails
- Individual laser-quality printing according to specifications

**For custom printing:** Please send us a file of our labeling software M-Print PRO or M-Print PRO Online (without installation) for your labeling specifications.

### General ordering data

Type	ESG 6/17 K MC NE WS	Version
Order No.	<a href="#">1880120000</a>	ESG, Device markers x 17 mm, PA 66, Colour: white, Self-adhesive
GTIN (EAN)	4032248478804	
Qty.	200 pc(s).	

Type	ESG 6/17 K MC NE GE	Version
Order No.	<a href="#">1880110000</a>	ESG, Device markers x 17 mm, PA 66, Colour: yellow, Self-adhesive
GTIN (EAN)	4032248478798	
Qty.	200 pc(s).	

## ESG 6/15



### Guaranteed long service life: ESG

The multi-colour and multi-format labels have a strong adhesive layer to ensure the best possible adhesion to the underlying surface. Double laminated polyester makes the basic material very thin and yet extremely tear-resistant.

### Your benefits with MultiMark

- "Different materials for various requirements"
- Can be used with equipment from many manufacturers
- Device markers with a familiar design

### General ordering data

Type	ESG 6/15 MM WS	Version
Order No.	<a href="#">2619940000</a>	ESG, Device markers, 6 x 15 mm, white
GTIN (EAN)	4050118626148	
Qty.	3,000 pc(s).	



**DRM270110LT**

**Weidmüller Interface GmbH & Co. KG**  
 Klingenbergstraße 26  
 D-32758 Detmold  
 Germany

www.weidmueller.com

**Accessories**

**LED / free-wheel diode**



Pluggable protective modules for the D-SERIES relay sockets, with optional protective functions.

- With green LED and free-wheeling diode

**General ordering data**

Type	RIM 2 110/230VDC	Version
Order No.	<a href="#">7760056017</a>	D-SERIES, LED module with freewheel diode, Rated control voltage:
GTIN (EAN)	4032248896615	110...230 V DC, Plug-in connection
Qty.	10 pc(s).	

**Blank**



ESG is the tried-and-tested marker in MultiCard format for use on many well-known electrical devices. The result is high-quality device marking with a high-contrast appearance.

Various types are available for devices from manufacturers like Siemens, ABB, Beckhoff etc. Advantages at a glance:

- Tags for universal usage, self-adhesive or clip-on tags, depending on type
- For aligned equipment, e.g. circuit breakers, we supply ESG markers for clipping onto tag rails
- Individual laser-quality printing according to specifications

**For custom printing:** Please send us a file of our labeling software M-Print PRO or M-Print PRO Online (without installation) for your labeling specifications.

**General ordering data**

Type	ESG 9/26 SCM ECO MC NE ...	Version
Order No.	<a href="#">1520980000</a>	ESG, Device markers x 26 mm, PA 66, Colour: white
GTIN (EAN)	4050118327939	
Qty.	80 pc(s).	

Type	ESG 9/26 SCM ECO MC NE ...	Version
Order No.	<a href="#">1521000000</a>	ESG, Device markers x 26 mm, PA 66, Colour: grey
GTIN (EAN)	4050118327878	
Qty.	80 pc(s).	

Type	ESG 9/26 SCM ECO MC NE ...	Version
Order No.	<a href="#">1520990000</a>	ESG, Device markers x 26 mm, PA 66, Colour: yellow
GTIN (EAN)	4050118327861	
Qty.	80 pc(s).	

## DRM270110LT

**Weidmüller Interface GmbH & Co. KG**  
Klingenbergstraße 26  
D-32758 Detmold  
Germany

www.weidmueller.com

## Accessories

## LED



Pluggable protective modules for the D-SERIES relay sockets, with optional protective functions.

- With green LED

## General ordering data

Type	RIM 3 110/230VUC	Version
Order No.	<a href="#">7940018455</a>	D-SERIES, LED module, Rated control voltage: 110...230 V UC, Plug-in connection
GTIN (EAN)	4032248878185	
Qty.	20 pc(s).	

## Sockets



Relay sockets for the D-SERIES DRM relays

- 2 and 4 CO contacts
- Screw and PUSH IN connection
- Standard and low heights

## General ordering data

Type	SCM 2CO P	Version
Order No.	<a href="#">7760056362</a>	D-SERIES DRM, Relay socket, Number of contacts: 2, CO contact, Continuous current: 12 A, PUSH IN
GTIN (EAN)	6944169772269	
Qty.	10 pc(s).	
Type	SCM 4CO P	Version
Order No.	<a href="#">7760056363</a>	D-SERIES DRM, Relay socket, Number of contacts: 4, CO contact, Continuous current: 6 A, PUSH IN
GTIN (EAN)	6944169772276	
Qty.	10 pc(s).	
Type	FS 4CO	Version
Order No.	<a href="#">7760056107</a>	D-SERIES DRM, Relay socket, Number of contacts: 4, CO contact, Continuous current: 10 A, Screw connection
GTIN (EAN)	4032248855575	
Qty.	10 pc(s).	
Type	SCM 4CO ECO	Version
Order No.	<a href="#">7760056264</a>	D-SERIES DRM, Relay socket, Number of contacts: 4, CO contact, Continuous current: 6 A, Screw connection
GTIN (EAN)	6944169662973	
Qty.	10 pc(s).	
Type	SCM 2CO ECO	Version
Order No.	<a href="#">7760056263</a>	D-SERIES DRM, Relay socket, Number of contacts: 2, CO contact, Continuous current: 12 A, Screw connection
GTIN (EAN)	6944169662966	
Qty.	10 pc(s).	

**Data sheet**

**DRM270110LT**

**Weidmüller Interface GmbH & Co. KG**  
 Klingenbergstraße 26  
 D-32758 Detmold  
 Germany

www.weidmueller.com

**Accessories**

Type	FS 2CO	Version
Order No.	<a href="#">7760056106</a>	D-SERIES DRM, Relay socket, Number of contacts: 2, CO contact,
GTIN (EAN)	4032248855582	Continuous current: 12 A, Screw connection
Qty.	10 pc(s).	

**Retaining clips**



Retaining clip for D-SERIES DRM relays  
 • Metal and plastic retaining clip

**General ordering data**

Type	DRM/DRL CLIP M	Version
Order No.	<a href="#">7760056108</a>	D-SERIES, Retaining clip
GTIN (EAN)	4032248855568	
Qty.	10 pc(s).	
Type	SCM CLIP P	Version
Order No.	<a href="#">7760056367</a>	D-SERIES DRM, Retaining clip
GTIN (EAN)	6944169773334	
Qty.	5 pc(s).	

**Data sheet**

**DRM270110LT**

**Weidmüller Interface GmbH & Co. KG**  
 Klingenbergstraße 26  
 D-32758 Detmold  
 Germany

www.weidmueller.com

**Drawings**

**Miscellaneous**

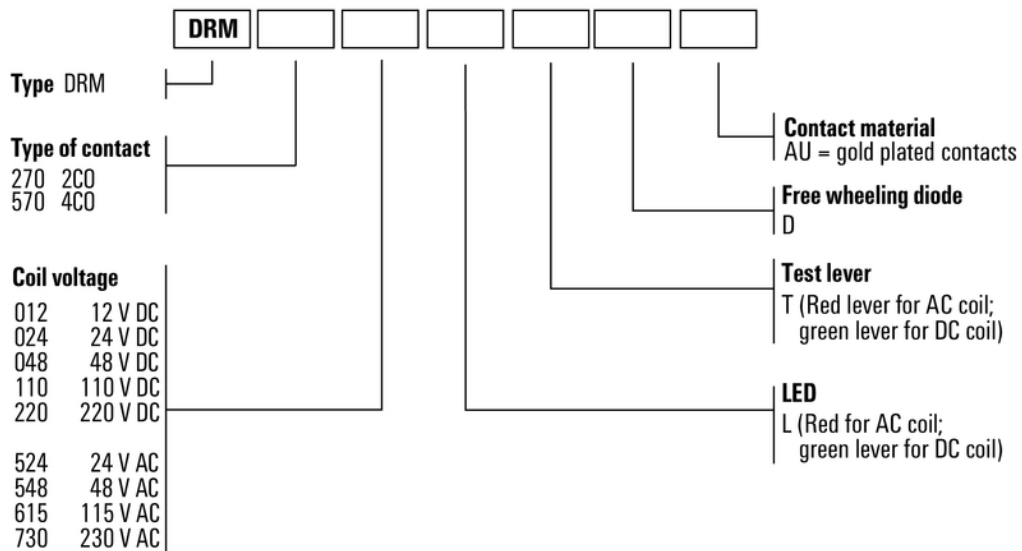

Type codes